

General Description

FSMOS[®] MOSFET is based on Oriental Semiconductor's unique device design to achieve low $R_{DS(ON)}$, low gate charge, fast switching and excellent avalanche characteristics. The high V_{th} series is specially designed to use in motor control systems with driving voltage of more than 10V.

Features

- Low $R_{DS(ON)}$ & FOM
- Extremely low switching loss
- Excellent reliability and uniformity
- Fast switching and soft recovery



Applications

- PD charger
- Motor driver
- Switching voltage regulator
- DC-DC convertor
- Switching mode power supply

Key Performance Parameters

Parameter	Value	Unit
V_{DS}	100	V
I_D , pulse	544	A
$R_{DS(ON), max}$ @ $V_{GS}=10V$	4	m Ω
Q_g	51	nC
PD	140	W

Marking Information

Product Name	Package	Marking
SFS10R04PNF	TO220	SFS10R04PN

Package & Pin information

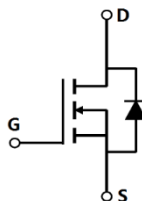

Absolute Maximum Ratings at $T_j=25^\circ\text{C}$ unless otherwise noted

Parameter	Symbol	Value	Unit
Drain-source voltage	V_{DS}	100	V
Gate-source voltage	V_{GS}	± 20	V
Continuous drain current ¹⁾ , $T_C=25^\circ\text{C}$	I_D	136	A
Pulsed drain current ²⁾ , $T_C=25^\circ\text{C}$	$I_{D, pulse}$	544	A
Continuous diode forward current ¹⁾ , $T_C=25^\circ\text{C}$	I_S	136	A
Diode pulsed current ²⁾ , $T_C=25^\circ\text{C}$	$I_{S, pulse}$	544	A
Power dissipation ³⁾ , $T_C=25^\circ\text{C}$	P_D	140	W
Single pulsed avalanche energy ⁵⁾	E_{AS}	194	mJ
Operation and storage temperature	T_{stg}, T_j	-55 to 150	$^\circ\text{C}$

Thermal Characteristics

Parameter	Symbol	Value	Unit
Thermal resistance, junction-case	$R_{\theta JC}$	0.89	$^\circ\text{C/W}$
Thermal resistance, junction-ambient ⁴⁾	$R_{\theta JA}$	62	$^\circ\text{C/W}$

Electrical Characteristics at $T_j=25^\circ\text{C}$ unless otherwise specified

Parameter	Symbol	Min.	Typ.	Max.	Unit	Test condition
Drain-source breakdown voltage	BV_{DSS}	100			V	$V_{GS}=0\text{ V}, I_D=250\ \mu\text{A}$
Gate threshold voltage	$V_{GS(th)}$	2		4	V	$V_{DS}=V_{GS}, I_D=250\ \mu\text{A}$
Drain-source on-state resistance	$R_{DS(ON)}$		3.3	4	m Ω	$V_{GS}=10\text{ V}, I_D=50\text{ A}$
Gate-source leakage current	I_{GSS}			100	nA	$V_{GS}=20\text{ V}$
				-100		$V_{GS}=-20\text{ V}$
Drain-source leakage current	I_{DSS}			1	μA	$V_{DS}=100\text{ V}, V_{GS}=0\text{ V}$
Gate resistance	R_G		2		Ω	$f=1\text{ MHz}$, Open drain

Dynamic Characteristics

Parameter	Symbol	Min.	Typ.	Max.	Unit	Test condition
Input capacitance	C_{iss}		3590		pF	$V_{GS}=0\text{ V}$, $V_{DS}=25\text{ V}$, $f=100\text{ kHz}$
Output capacitance	C_{oss}		2214		pF	
Reverse transfer capacitance	C_{rss}		136		pF	
Turn-on delay time	$t_{d(on)}$		20		ns	$V_{GS}=10\text{ V}$, $V_{DS}=50\text{ V}$, $R_G=2\ \Omega$, $I_D=25\text{ A}$
Rise time	t_r		12		ns	
Turn-off delay time	$t_{d(off)}$		32		ns	
Fall time	t_f		10.5		ns	

Gate Charge Characteristics

Parameter	Symbol	Min.	Typ.	Max.	Unit	Test condition
Total gate charge	Q_g		51		nC	$V_{GS}=10\text{ V}$, $V_{DS}=50\text{ V}$, $I_D=25\text{ A}$
Gate-source charge	Q_{gs}		16		nC	
Gate-drain charge	Q_{gd}		14		nC	
Gate plateau voltage	$V_{plateau}$		4.7		V	

Body Diode Characteristics

Parameter	Symbol	Min.	Typ.	Max.	Unit	Test condition
Diode forward voltage	V_{SD}			1.3	V	$I_S=50\text{ A}$, $V_{GS}=0\text{ V}$
Reverse recovery time	t_{rr}		48		ns	$V_R=50\text{ V}$, $I_S=25\text{ A}$, $di/dt=100\text{ A}/\mu\text{s}$
Reverse recovery charge	Q_{rr}		135		nC	
Peak reverse recovery current	I_{rrm}		4		A	

Note

- 1) Calculated continuous current based on maximum allowable junction temperature.
- 2) Repetitive rating; pulse width limited by max. junction temperature.
- 3) P_d is based on max. junction temperature, using junction-case thermal resistance.
- 4) The value of $R_{\theta JA}$ is measured with the device mounted on 1 inch² FR-4 board with 2oz. Copper, in a still air environment with $T_a=25\text{ }^\circ\text{C}$.
- 5) $V_{DD}=50\text{ V}$, $V_{GS}=10\text{ V}$, $L=0.3\text{ mH}$, starting $T_j=25\text{ }^\circ\text{C}$.

Electrical Characteristics Diagrams

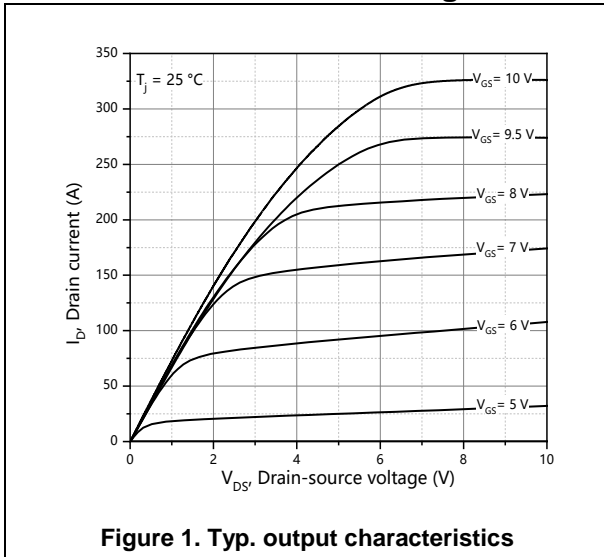

Figure 1. Typ. output characteristics

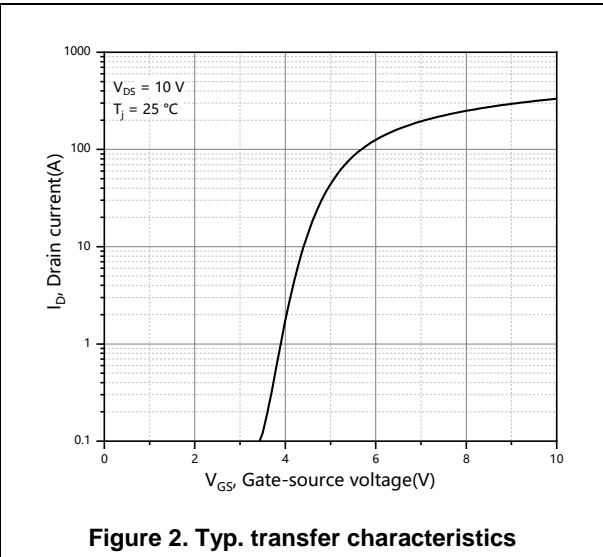

Figure 2. Typ. transfer characteristics

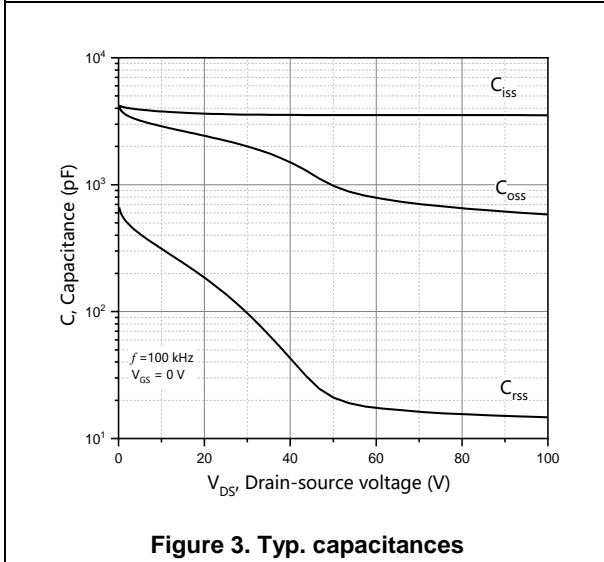

Figure 3. Typ. capacitances

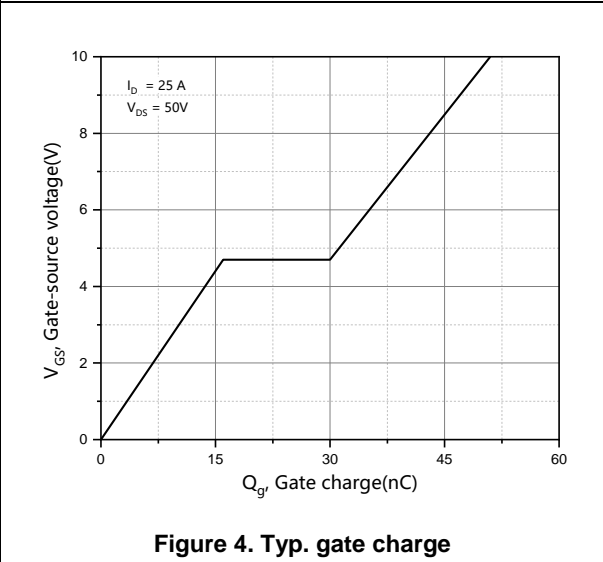

Figure 4. Typ. gate charge

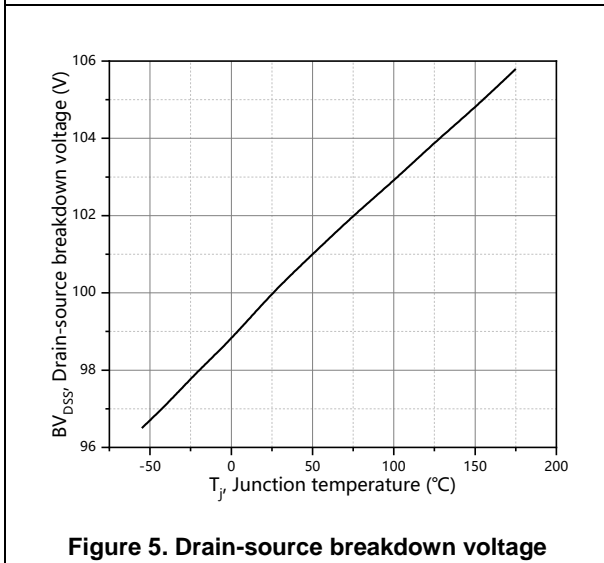

Figure 5. Drain-source breakdown voltage

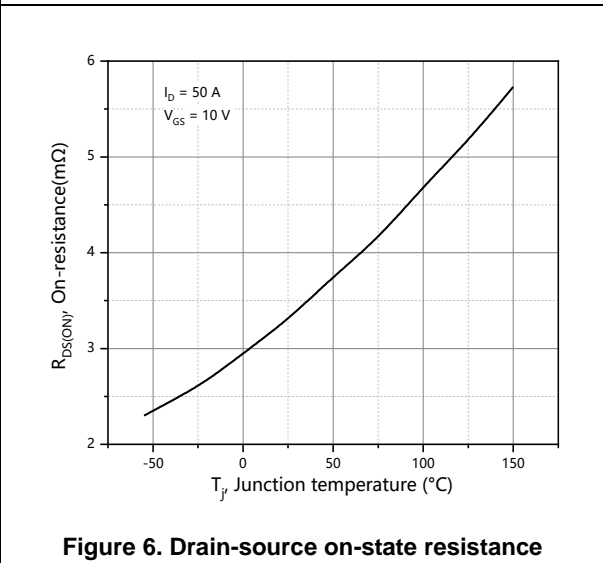
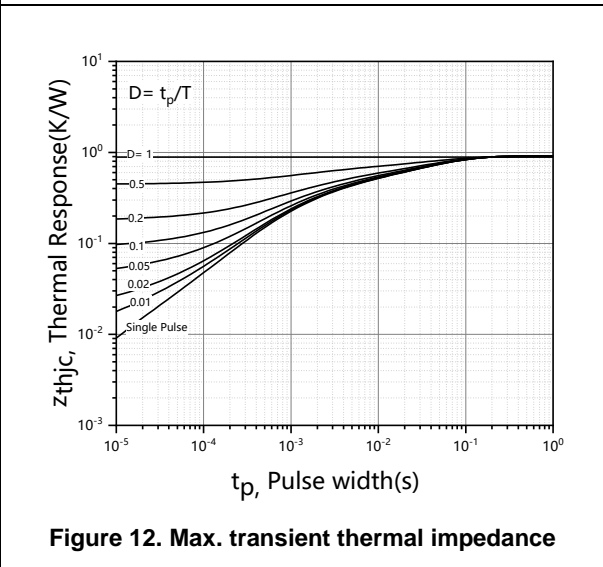
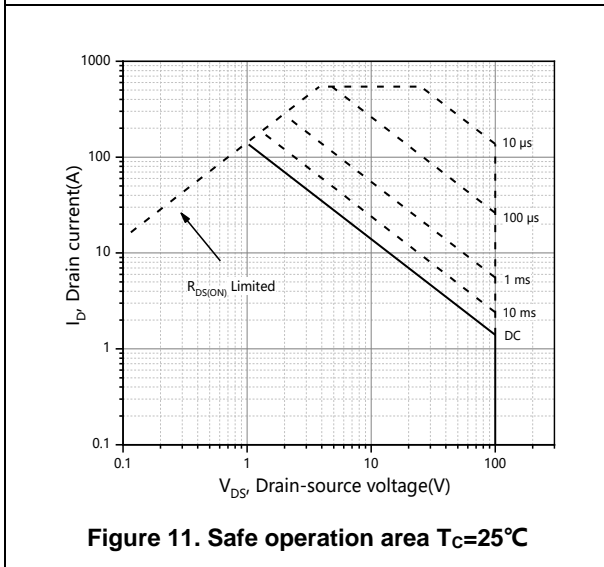
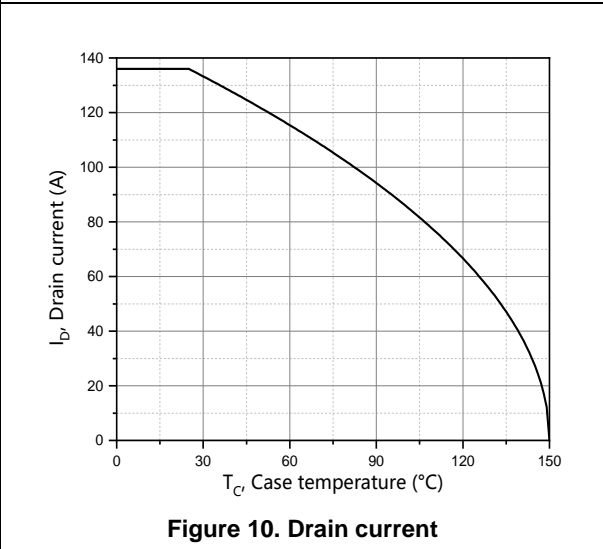
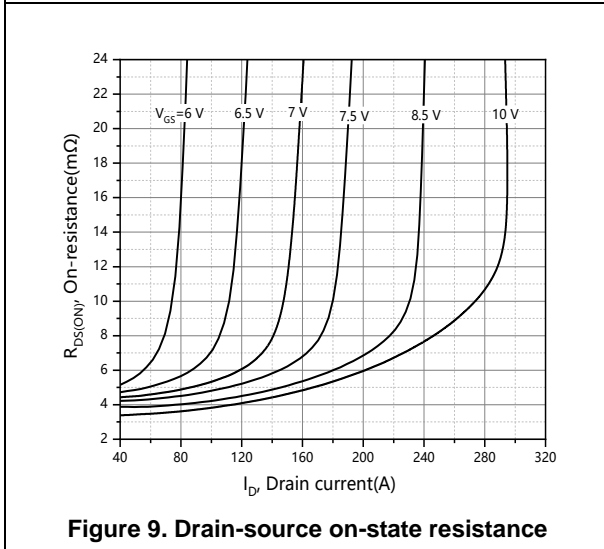
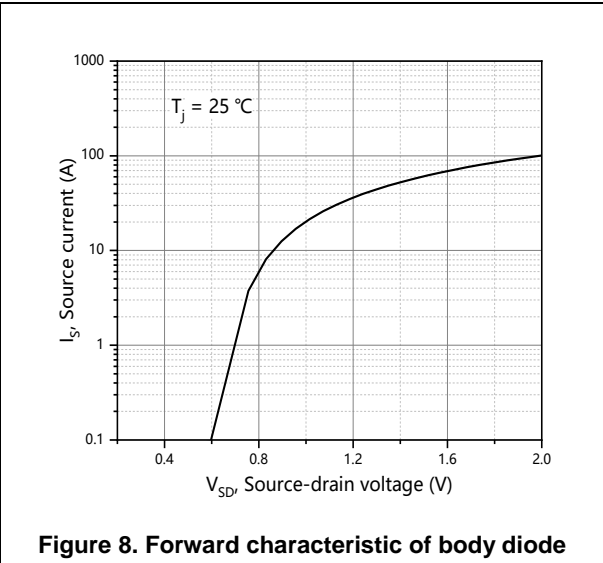
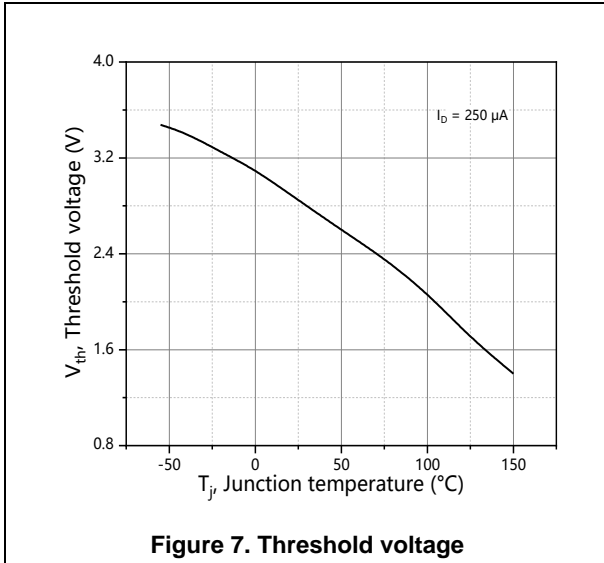

Figure 6. Drain-source on-state resistance



Test circuits and waveforms

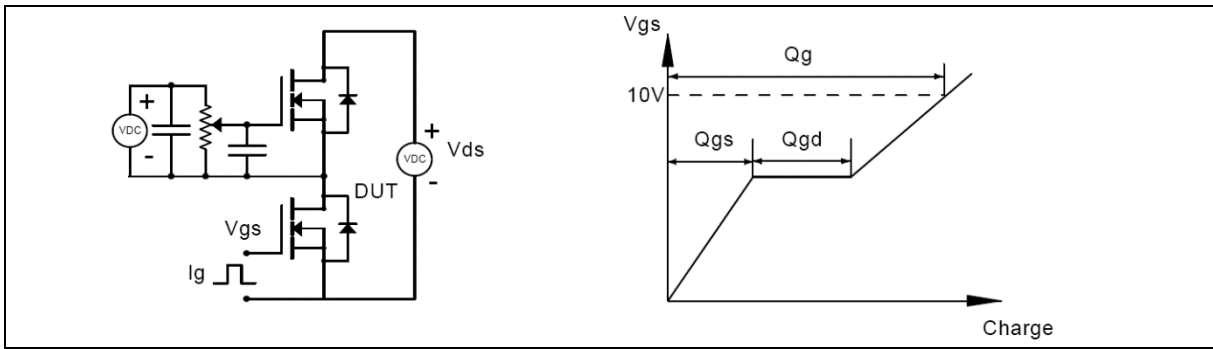

Figure 1. Gate charge test circuit & waveform

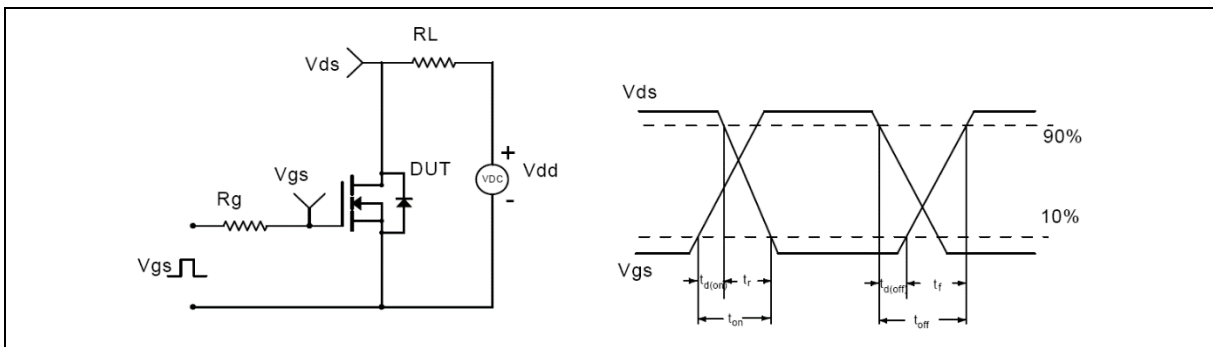

Figure 2. Switching time test circuit & waveforms

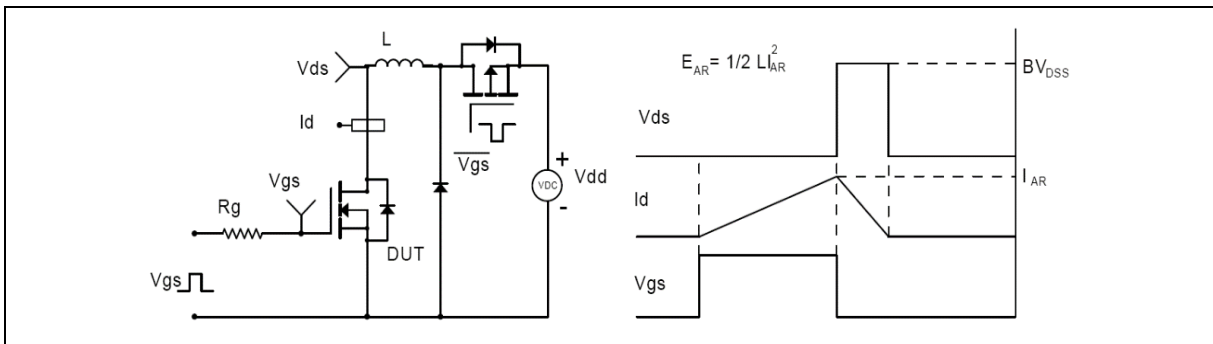

Figure 3. Unclamped inductive switching (UIS) test circuit & waveforms

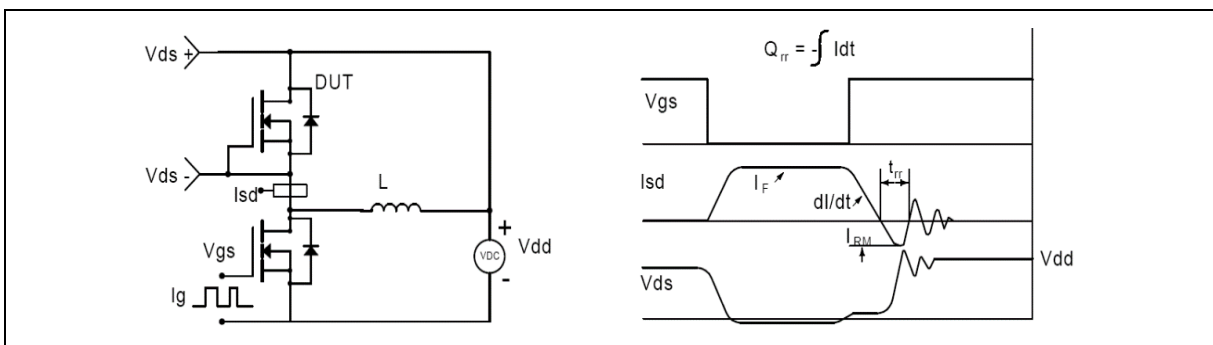
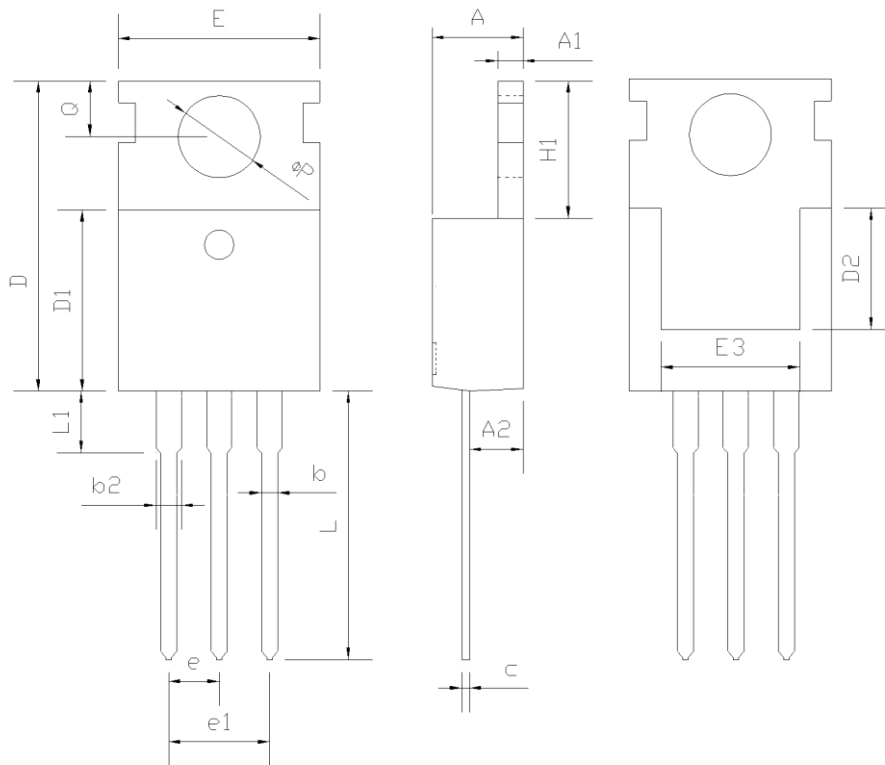

Figure 4. Diode reverse recovery test circuit & waveforms

Package Information



Symbol	mm		
	Min	Nom	Max
A	4.37	4.57	4.77
A1	1.25	1.30	1.45
A2	2.20	2.40	2.60
b	0.70	0.80	0.95
b2	1.17	1.27	1.47
c	0.40	0.50	0.65
D	15.10	15.60	16.10
D1	8.80	9.10	9.40
D2	5.50	-	-
E	9.70	10.00	10.30
E3	7.00	-	-
e	2.54 BSC		
e1	5.08 BSC		
H1	6.25	6.50	6.85
L	12.75	13.50	13.80
L1	-	3.10	3.40
ΦP	3.40	3.60	3.80
Q	2.60	2.80	3.00

Version : TO220-P package outline dimension

Ordering Information

Package Type	Units/ Reel	Reels / Inner Box	Units/ Inner Box	Inner Boxes/ Carton Box	Units/ Carton Box
TO220-P	50	20	1000	5	5000

Product Information

Product	Package	Pb Free	RoHS	Halogen Free
SFS10R04PNF	TO220	yes	yes	yes

Legal Disclaimer

The information given in this document shall in no event be regarded as a guarantee of conditions or characteristics. With respect to any examples or hints given herein, any typical values stated herein and/or any information regarding the application of the device, Oriental Semiconductor hereby disclaims any and all warranties and liabilities of any kind, including without limitation, warranties of non-infringement of intellectual property rights of any third party.

For further information on technology, delivery terms and conditions and prices, please contact the Oriental Semiconductor sales representatives (www.orientalsemi.com).

© Oriental Semiconductor Co.,Ltd. All Rights Reserved 